

TOX®-Clinching Technology Installation and design guidelines

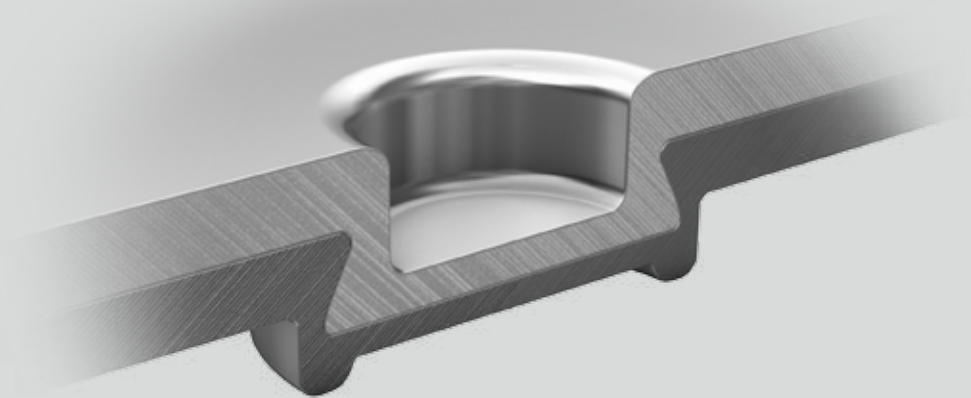
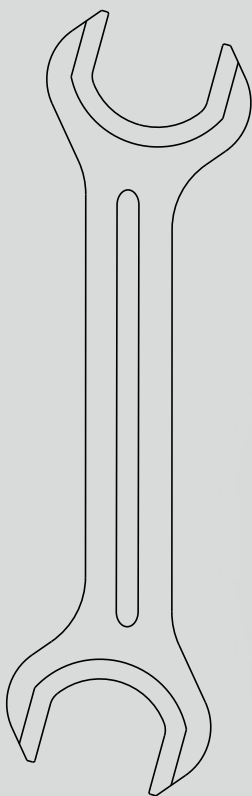

Data
sheet
80.18

2017/10

TOX® PRESSOTECHNIK GmbH & Co. KG
Riedstrasse 4
D-88250 Weingarten

Find your local contact at:
www.tox-pressotechnik.com

Installation and design guidelines

Basics

The basics for the mechanical as well as technological design of a TOX®-Clinching Joint is the TOX®-Test Report

Drive technology

For the drive, pneumatic, hydraulic or electromechanical equipment can be used. Thanks to their special running characteristics, on the one hand the pneumo-hydraulic drive, the TOX®-Powerpackage, as well as the servo drives from the TOX®-Electric Drive series are ideally suited and offer a number of decisive advantages.

Technology

As a general rule, the larger the point diameter, the greater the joint strength.

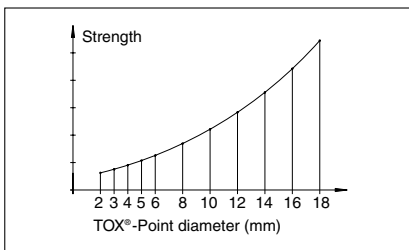

*Joint strength (shear and pull)

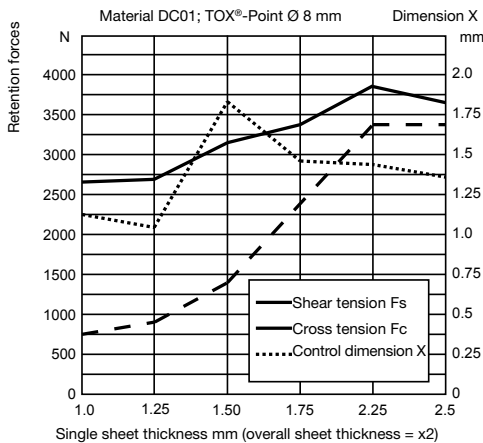

Changes in material thickness:

The diagram shows the strength of the TOX®-Joint over a wide range of material thickness, using the same TOX®-Tool combination, while changing the press force and quality control dimension X.

Performed with a tool set, point diameter 8 mm, for all thicknesses.

Operational monitoring

If the press force is too low, no joint will be formed, but if it is too high, this can lead to breakage of the tool. The TOX®-Powerpackage provides an optimal monitoring facility for ensuring the right pressing force. When the set pressing force is reached, the return stroke is initiated via an impulse from an oil high-pressure switch. If the press force is not reached, e.g. due to a pressure drop in the pneumatic system, this switch-over does not take place and the TOX®-Powerpackage stops. This provides an ideal way of checking the press force for each TOX®-Point.

Process monitoring

Continuous monitoring during the production process can be achieved using our process monitoring system.

Operating safety precautions

Tools must not be closed without material. Without material, the surface pressure at the tool is too high and leads to deformation or tool damage. This can be easily avoided by setting stroke limiters. They should basically be applied so that the control dimension X is obtained when the tool with sheet metal is closed.

Testing

Testing of the TOX®-Joint can be carried out non-destructively by measuring the remaining bottom thickness of the TOX®-Point, the control dimension X. The dimension X allows to establish correlation with the shear and pull load carrying capabilities of the joint.

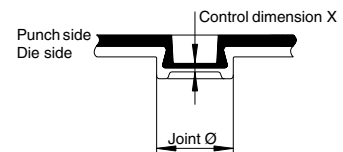

The measurement must be performed using a measuring probe, e.g. type CMT (see data sheet TOX®-Measuring Equipment 80.09) in the center of the die.

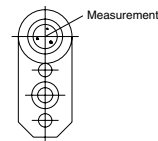

The control dimension X is contained in the TOX®-Test Report and has a tolerance of $\pm 15\%$. For sheet thicknesses of less than 0.8 mm, this tolerance is reduced (see test report for precise details). During its service life, the bottom of the die may show wear. This does not influence the quality of the TOX®-Point as long as the die bottom is not lowered by more than 0.1 mm. After a re-adjustment, the point durability must be checked.

We recommend testing an actual production sample to determine whether the strength of the joints is adequate.

No chisel test

In welding technology, durability is tested, for want of a better method, by driving a chisel between the sheets at the welding spot. In contrast, the quality of the TOX®-Joint can be checked non-destructively by simply measuring the control dimension X.

Installation and design guidelines

Basics

Installation information

There is a risk of breakage as the tool shank hits the **bending radius**. The shoulder of the TOX®-Tools should, therefore, not make contact with the sheet.

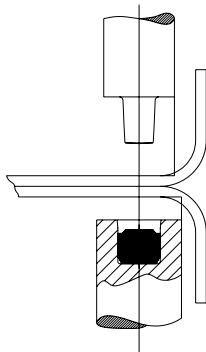

For systems with circular tool movement, e.g. TOX®-PowerKurve, the punch should be placed vertically on the sheet. This ensures similar durability to that of a linear tool feed.

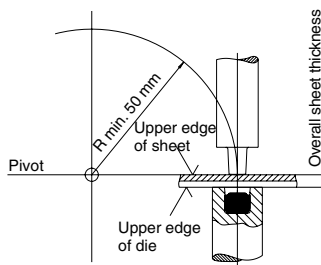

Also with component parts which are molded or do not lie flat, make sure that the "calibration", which is required as a result is not performed by the TOX®-Tool. Please contact TOX® PRESSOTECHNIK.

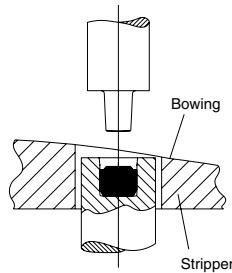

The strength of the holding fixtures must be able to stand up to the pressure loads of the TOX®-Tools in continuous operation. The press force is set according to the TOX®-Test Report and the pressure area according to the tool shaft diameter or contact area.

Pressure load = 350 N/mm²
(Conforms to safety S = 3)

Due to the point elevation, either the component or the die needs to be moved for removal.

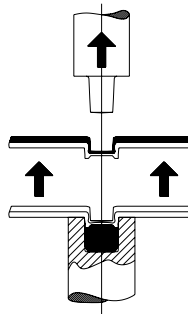

Tolerances

Please observe the tolerances and exact fixing when installing the TOX®-Tools. The tolerances of the TOX®-Tools are designed to ensure secure fixing.

It is essential that the alignment tolerance should be maintained between the punch and die.

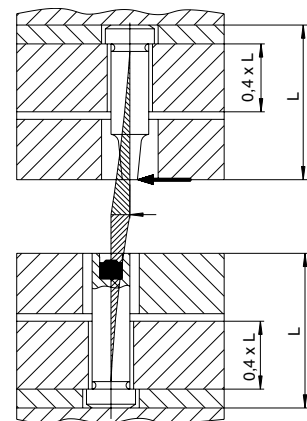

These tolerances ensure the flexible bearing which is so important for the TOX®-Process.

Before mounting the TOX®-Tools to the holding plate, coat them slightly with grease.

Specification

Depending to the TOX®-Test Report it might be necessary to spray the workpiece surface and / or the TOX®-Tools with a suitable lubricant before the joining process. In these cases, the use of components of the TOX®-Spraying System (e.g. spray nozzles) must be considered constructively (see data sheet TOX®-Spraying System 80.02).

Installation and design guidelines

Stripper basics

Stripper

The stripping force to be considered is specified in the TOX®-Test Report. In the case of multiple point tools with a common stripper plate, this value should be multiplied by the number of points.

Withdrawing the punch or die forcibly without the stripper can cause deformation of the TOX®-Point and reduce its strength. There is also a risk of breaking the TOX®-Tools. Excessively high stripping forces affect the shaping process and reduce durability of the TOX®-Point.

Important

The stripper must not touch the TOX®-Tools, otherwise there is a risk of tool breakage due to side forces.

The stripping distance on the punch side must be \geq the penetration depth (PD) of the punch neck. For die side stripper travel: DD (per TOX®-Test Report) + 1.0 mm (+ part clearance if needed).

Selection of spring and stripper

1. See stripping force indicated in the TOX®-Test Report.
2. The spring is preloaded in the stripper with F_v .
3. When producing the point, the punch travel is PD = penetration depth. With this, the stripping force is increased by the spring rate R. With increasing spring travel, the lifetime of the spring is reduced, f_{max} must not be exceeded.

4. Calculation of PD = penetration depth:

$$PD = S_1 + S_2 + DD - X$$

DD = Die depth from TOX®-Test Report

X = Control dimension from the TOX®-Test Report

S_1 = Thickness of material punch side

S_2 = Thickness of material die side

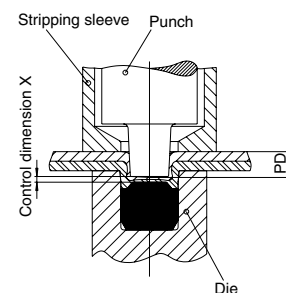
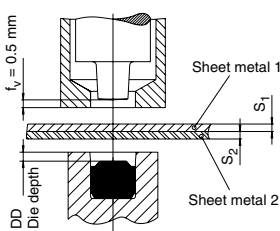

Round point die

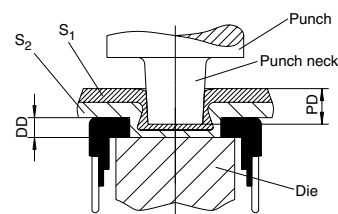

SKB-die

5. Calculation of the stripping force F of stripper:

$$F = R \cdot (PD + f_v) + F_v$$

F_v = Preload force from data sheet 80.07

R = Rate of spring from data sheet 80.07

6. Using materials with a tendency to excessive cold welding (e.g. aluminum), the punch stripping sleeve must tightly embrace the punch neck in order to avoid a drawing-up of the material during the stripping process.

Installation and design guidelines TOX®-Round Joint Tools

Tool life quantities for TOX®-Round Joint Tools:

With qualified mechanical realization and observance of our mounting instructions and test report data, the following tool life quantities and more can be expected during the life of each tool set:

DC01: 100,000 – 400,000 joining points

H340LAD: 100,000 – 350,000 joining points

Aluminum: 100,000 – 350,000 joining points

Stainless steel: 20,000 – 150,000 joining points

Punch and die changes are mandatory in case of:

- tool rupture
- continuous reduction of the joining point strength e.g. due to tool wear.

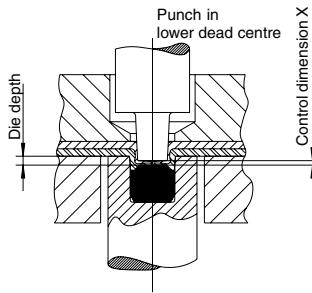

Oil drainage system

All the die forms with insert feature an oil drainage system. This system is necessary for very oily sheet metal and when using spray equipment.

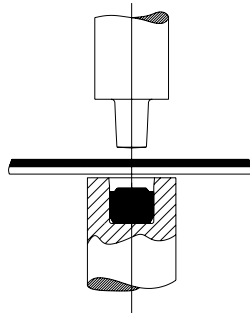

Stripper

Strippers are necessary on punch and die side and must be directly attached to the TOX®-Tool.

An inclination of the TOX®-Tools to the surface of the sheet metal of max. 3° is allowed with slightly lower joint strength.

The installation options shown here are applicable for both, flat dies and offset dies.

Installation with groove

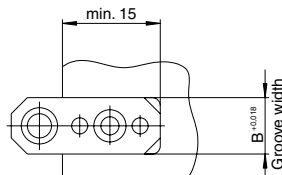
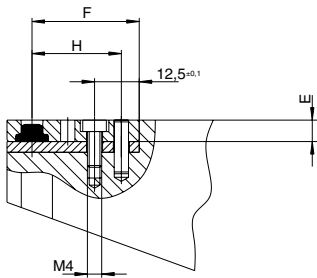

Installation with dowel pin

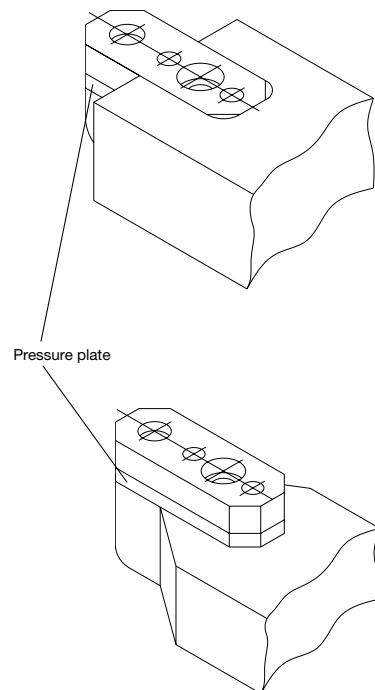
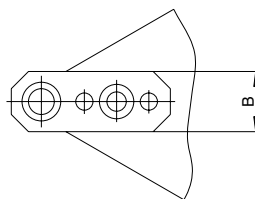
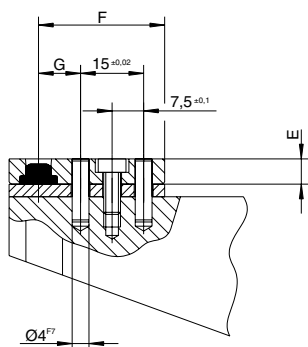

The die should always be supported by a pressure plate or hardened shim plate.

Caution: Observe installation guidelines and TOX®-Test Report

Installation and design guidelines

TOX®-SKB Die

The installation and design guidelines for TOX®-SKB Dies are not much different than those for the TOX®-Round Joint process. The following guidelines apply exclusively to the SKB die:

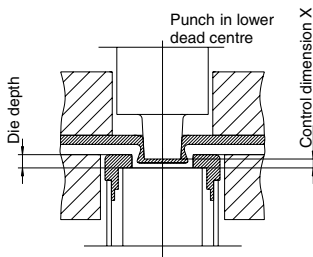

Caution

The rejoining of an already created point can cause the destruction of the TOX®-SKB Die and of the joint.

Stripper

Strippers are necessary on the punch side and must be placed directly on the TOX®-Tool.

The close sitting of the die to the sheet metal on the die side is compulsory. Marks of firm parts may be slightly visible but must be uniform.

An inclination of the TOX®-Tools to the sheet metal surface $\leq 1^\circ$ is allowed with a slight reduction of the retaining forces.

The flange must be wide enough to fully cover the die diameter. Partial overlap results in loss of strength and in potential cracks in the die side material.

Tool life quantities during the life of TOX®-Joining Tools with SKB die:

With qualified mechanical realization and observance of our installation instructions and test report data, the following tool life quantities and more can be expected during the life of each tool set:

DC01: 200,000 – 400,000 joining points

H340LAD: 200,000 – 350,000 joining points

Aluminum: 200,000 – 350,000 joining points

Punch and die changes are mandatory in case of:

- tool rupture
- continuous reduction of the retention forces
- tool wear

TOX®-SKB Die – Ideal for complex clinching applications

The strengths of the TOX®-SKB Die

- + specially suitable for hybrid joining „Clinching + Glueing“ in connection with intermediate layers
- + due to the high flexibility regarding sheet metal thicknesses, only few standardized die types are required and the application flexibility is increased

- 1 Moving segment
- 2 Fixed segment
- 3 Spring elements

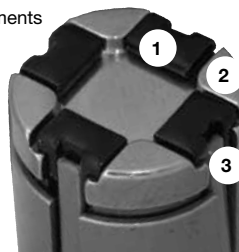

Even in the case of missing moving segments, the SKB die produces a very strong joint. The process reliability is immensely increased compared to a die with only moving segments.

Installation in column-mounted tools

Please take into consideration $\varnothing Y$ for SKB dies compared to the TOX®-Round Joint tools with solid die (see data sheet Clinching Tools and Accessories 80.07).

Caution: Observe installation guidelines and TOX®-Test Report

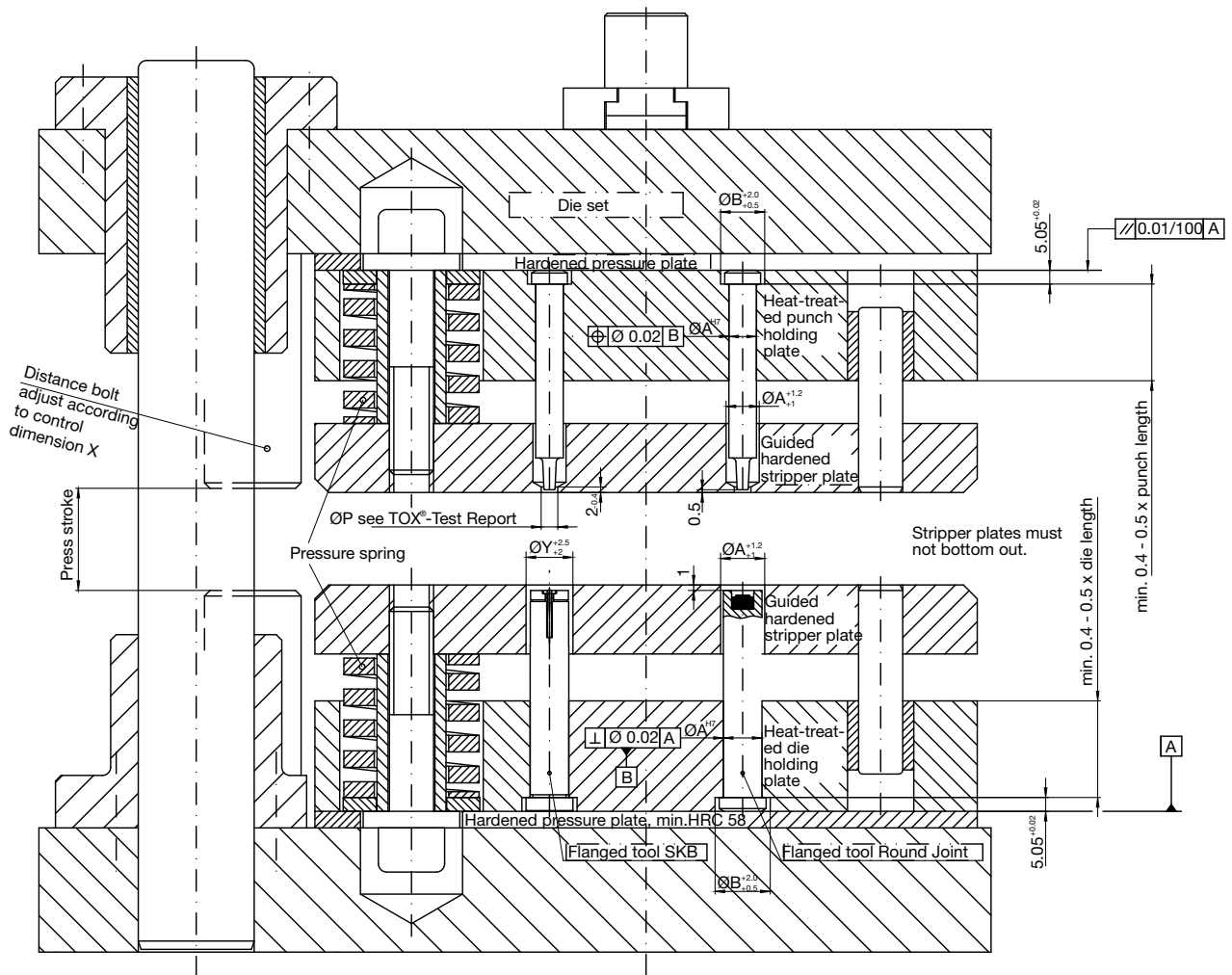

Design guidelines

Distances and flange dimensions

The values below are intended as a design requirement for designers of the TOX®-Joining process.

If it is not possible to design your particular application using this guideline, please contact us.

Point diameter [mm]	Round Point Die							SKB Die			
	3	4	5	6	preferred series			6	8	8**	10
Sheet thickness Punch side [mm] S_1	$S_1 = \text{approx. } 2.5 \text{ to } 3.0 \times S_2$										
Sheet thickness Die side [mm] S_2	$S_2 = \text{approx. } 2 \text{ to } 2.5 \times S_1$										
Overall sheet thickness [mm] $S_1 + S_2$	0.5 - 1.5	0.6 - 2.0	1.0 - 2.5	1.0 - 3.0	1.6 - 6.0	1.75 - 7.0	4.5 - 11.0	0.4 - 2.5	0.6 - 5.0	0.6 - 5.0	1.0 - 6.0
Edge distance [mm] $\geq a$	5	5	5	6	7	8	10	7	8	9	9
Distance to start of border radius [mm] $\geq b$	5	5	5	7	7	8	10	7	8	9	9
Point to point distance [mm] $\geq e^*$	10	10	10	12	14	16	20	14	16	18	18
Min. die height [mm]	6	6	6	6	6	6	6	14	14	14	14
Clearance [mm] $\geq d$	15	15	20	20	20	25	30	30	30	30	35
Flange length [mm] Z	unlimited										

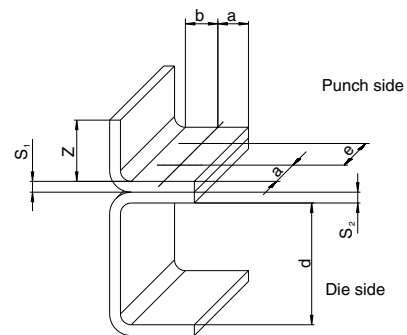
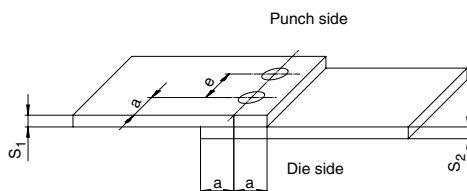

* + tolerance range

Please take note of the stripper dimensions when determining the distance from edges and radius borders (a, b, as well as the points to one another (e)) (see data sheet Clinching Tools and Accessories 80.07).

****Attention:** with glue applications or other intermediate layers, the die shaft diameter 16.0mm must be used for TOX®-Point SKB 8.

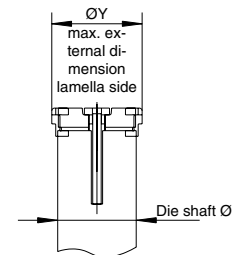

Please take into consideration $\varnothing Y$ for SKB dies compared to the TOX®-Round Joint tools with solid die (see data sheet Clinching Tools and Accessories 80.07).

TOX®-Joint Diameters for various materials

Efficiency of the TOX®-Clinching Technology

Sheet material

- + metallic
- + same materials
- + different materials
- + sheets/profiles

Recommendation

- Material **hard** (punch side)
- Material **soft** (die side)

Sheet thickness

- + same thickness
- + thick in thin 2.5 : 1
thin in thick 1:2
- + min. single thickness approx. 0.2mm
- + max. overall thickness approx. 12.0mm

Recommendation

- Sheet **thick** (punch side)
- Sheet **thin** (die side)

Sheet surface

- + dry
- + oiled
- + uncoated
- + coated on one
or all sides
- + painted
- + plastic-coated

Sheet layers

- + 2 ply
- + 3 ply
- + intermediate:
textil
plastic
plastic foils
paper
adhesive
etc.

The journey to reliable and quick clinching joint

On the following pages, material combinations, material thicknesses and the corresponding TOX®-Joint diameters can be found. Additionally, you get **information on the feasible holding forces** and the required point diameter.

You will receive detailed data and our guarantee for your joint with a TOX®-Test Report from our test lab. For this purpose, please complete the form on the last page and send it together with your test material to TOX® PRESSOTECHNIK.

Material designation

Designation EN 10027	Designation DIN 17600	Designation EN 10027	Designation DIN 17600	Designation EN 10027	Designation DIN 17600
DC01	St 12	DX52 (Z)	St 03 Z 275 SB	H340LAD	ZStE 340
DC01	St 1203	DX53	St 05	H420LAD	ZStE 420
DC01	St 2k 60	DX53D (Z)	ST 05 Z140 NA	S235	ST 37
DC03	RRSt 13	DX54D	St 06Z	S315	QStE 300
DC04	FePo4	ENAW-5182	AlMg5Mn	S355	QSt 52-3
DC04	St 14	ENAW-5182	AlMg5Mn W27 bonazinc	S355	St 52
DC04	St 1403	ENAW-5754 H111	AlMg3 W19	S380	QStE 380
DC04 (Z)	St14 ZE75	ENAW-5754 H12	AlMg3F22	S420	QStE 420
DX51D	St 02	ENAW-5754 H12	AlMg3F22	S500	QStE 500
DX52	St 3	H220BD	ZStE 220		

Special steel

TOX®-Round Joint Ø (mm)	Total sheet thickness (mm)		material/coating		shear strength (N)	tensile strength (N)	pressing force (kN)
	punch side	die side	punch side	die side			
10	2.50	1.25	1.4401	1.4401	8500	4400	105
8	0.60	2.00	1.4016	1.4016	1600	1300	67
6	0.50	0.50	1.4510	1.4510	1700	650	37
6	0.60	1.00	1.4016	1.4016	1800	1300	35
6	0.70	0.70	1.4016	1.4016	2000	1100	40
6	0.75	1.00	V2A	V2A	2000	1500	45
6	0.80	0.75	1.4301	1.4316	1700	950	40
6	0.90	0.90	1.403 plastic foil	1.403 plastic foil	2100	1050	42
6	1.00	1.00	1.4512	1.4512	2400	2200	40
6	1.00	1.00	1.4571	1.4571	2800	1650	37
6	1.00	1.00	1.4016	1.4016	2600	2100	47
6	1.25	0.60	1.4016	1.4016	3400	1400	32
5	0.60	0.60	1.4016	1.4016	1700	1000	30
5	0.70	0.70	special steel one side enameled	special steel one side enameled	1500	770	32
5	0.80	0.80	1.4301	1.4301	2000	930	30
4	0.80	0.80	1.4301	1.4301	1100	500	21

Others

TOX®-Round Joint Ø (mm)	Total sheet thickness (mm)		material/coating		shear strength (N)	tensile strength (N)	pressing force (kN)
	punch side	die side	punch side	die side			
12	6.00	5.00	Cu	Cu	6200	4200	101
6	0.30	0.60	tin plate	tin plate	560	320	30
6 T	0.80	0.80	Cu	Cu	1550	800	42
6 T	0.80	1.00	Cu ETP	Cu	1950	1200	43
6	1.00	1.00	Cu	Cu	1300	900	26
6	1.00	1.50	CW409J	CW409J	1600	1250	40
5	0.50	0.50	tin plate	tin plate	770	400	20
5 T	1.00	1.00	Cu ETP R290-3	Cu ETP R290-3	1600	1000	17
5 T	1.50	0.60	Cu ETP R290	Cu ETP R290	1750	500	23
4	0.70	0.80	brass, chromated	brass, chromated	930	500	14
4	0.75	0.50	CW505L	CW505L	730	350	13
4 T	0.80	0.60	Cu ETP	Cu ETP	1200	650	17
4 T	1.00	0.40	Cu ETP R240	Cu ETP R290-3	950	220	13
4	1.00	0.60	Ms63 nickeled	CW508L	1000	480	16
4 T	1.00	0.80	Cu ETP R240	Cu ETP R290-3	1300	600	15
3	0.40	0.75	CW409J Zn20	CW409J Zn20	240	110	10
3	0.80	0.30	new silver	new silver	450	210	9
3 T	0.80	0.80	E-Cu	E-Cu	400	350	12
3 T	0.80	1.20	E-Cu	E-Cu	300	180	9
2	0.25	0.25	CuSn0.15	CuSn0.15	125	55	3.5
2	0.60	0.60	CuZn37	CuZn37	260	60	3.6
2	0.80	0.30	C2600R-1/2	CAC19	390	170	4

T = TWINpoint. Diameter per single joint.

Examples of TOX®-Joint diameters and holding forces

Steel uncoated

TOX®- Round Joint Ø (mm)	Total sheet thickness (mm)		material/coating		shear strength (N)	tensile strength (N)	pressing force (kN)
	punch side	die side	punch side	die side			
12	3.00	2.00	DC01	DC01	7800	6100	98
10	0.75	1.00	DC01	DC01	3000	1600	82
10	1.00	0.75	DC01	DC01	3400	1100	82
10	1.00	1.00	DC01	DC01	3500	1700	72
10	1.00	1.50	DC01	DC01	3100	2500	86
10	1.50	1.00	DC01	DC01	5400	2200	89
10	2.00	0.90	DC01	DC01	4700	2100	57
10	2.00	2.00	S420MC	S420MC	4800	4000	70
10	2.00	2.75	S315	S315	3900	3300	68
10	2.50	2.50	DC01	DC01	5000	5300	76
10	3.00	3.00	DC01	DC01	6500	5800	95
8	0.75	1.00	DC01	DC01	2000	1200	51
8	0.75	1.25	H220BD	H220BD	1850	1600	45
8	1.00	1.00	H420LAD	H420LAD	4000	2200	52
8	1.00	1.00	DC01	DC01	2700	1400	49
8	1.00	1.50	DC01	DC01	2400	2700	54
8	1.00	2.00	DC01	DC01	2500	2400	55
8 T	1.20	1.20	H 400 TD	H 400 TD	4100	1950	70
8	1.50	1.00	DC01	DC01	3800	1900	60
8	1.50	1.50	H340LAD	H340LAD	3600	2000	50
8 T	2.00	1.50	S355MC	DD 13	8150	4750	75
8	2.00	2.00	S420MC	S420MC	3600	2600	55
8 T	2.00	2.00	S420MC	S420MC	8900	7050	79
8	3.00	1.50	S420MC	S420MC	6200	4400	50
6	0.60	0.60	H180BD	H180BD	1300	650	27
6 S	0.60	0.60	St 07	St 07	1100	580	21
6	0.75	1.00	DC01	DC01	1400	1200	36
6	1.00	0.75	DC01	DC01	2000	1000	36
6	1.00	1.00	DC01	DC01	1800	1400	33
6	1.00	1.50	DC01	DC01	1500	2100	40
6	1.50	1.00	DC01	DC01	2100	1800	28
6 T	1.50	1.50	St	St	1900	650	32
5	1.50	0.63	DC01	DC01	1700	800	17
5 T	1.50	1.00	DC01	DC01	3100	1500	39
4	1.00	1.00	DC01	DC01	1300	850	15
3	0.25	0.25	steel	steel	260	130	11
2	0.35	0.20	St	St	220	60	3

Steel coated/enamelled

TOX®- Round Joint Ø (mm)	Total sheet thickness (mm)		material/coating		shear strength (N)	tensile strength (N)	pressing force (kN)
	punch side	die side	punch side	die side			
12	3.00	2.50	DX53D (Z)	DX53D (Z)	6300	4300	62
12	3.00	3.00	S235JR	S235JR	7000	6000	120
12	3.30	3.30	S355JOC powder coated	S355JOC powder coated	7200	6200	100
12	4.00	4.00	S235JR	S235JR	7500	7500	120
10	1.45	1.70	DC01 (Z) SB	DC01 (Z) SB	3750	3400	62
10	1.50	2.00	DC01 galvanized	DC01 galvanized	3500	2600	65
10	2.00	2.00	DC01 enamelled	DC01 enamelled	3900	3800	65
10 S	2.50	1.00	DX51D	DX51D	4100	1200	43
10	3.00	3.00	DC01 galvanized	DC01 galvanized	6100	5300	7
10	4.00	2.50	steel enamelled	steel enamelled	6250	6200	78
8	0.40	2.00	DX51D	DX51D	510	290	44
8 S	0.60	0.80	DX56D	DX56D	1450	850	35
8 S	0.60	1.20	DX56D	DX56D	1100	950	38
8	0.70	1.20	DX54D hot galvanized	DX54D hot galvanized	1800	1000	50
8	0.75	1.25	DC04 galvanized	DC04 galvanized	2000	1400	38
8	0.90	0.90	DX53D enamelled	DX53D enamelled	2050	1500	62
8	0.90	0.90	DC01enamelled on one side	DC01 enamelled on one side	1900	1100	45
8	1.00	1.00	DX51D	DX51D	3500	2400	45
8	1.00	1.00	S235JR	S235JR	2500	1500	40
8	1.00	1.25	DX52D Z275 SB, enamelled	DX52D Z275 SB, enamelled	2100	1550	45
8	1.00	1.50	DX52D Z275 SB, enamelled	DX52D Z275 SB, enamelled	1950	1700	38
8 T	1.20	0.60	DX54D	DX54D	2600	750	36
8 T	1.20	1.50	DX53D	DX53D	2870	1800	42
8	1.25	1.25	steel powder coated	steel powder coated	2100	1300	37
8	1.50	0.80	DX51D	DC01	3300	2000	42
8	1.70	1.20	DC01 KTL-enamelled	DC01 KTL-enamelled	2800	1600	43
8	1.75	1.75	S380MC pickled	S380MC pickled	3350	2800	51
8	2.20	2.20	steel enamelled	steel enamelled	2900	2400	50
8	2.50	2.50	steel enamelled	steel enamelled	3350	2800	50
6 S	0.40	0.50	DX53D	DX51D	450	250	20
6 S	0.50	0.50	DX53D	DX51D	550	250	12
6	0.50	0.80	DC01 enamelled	DC01 bright	800	500	36
6	0.50	0.90	S235JR (Z)	S235JR (Z)	950	530	30
6	0.70	0.70	steel F30 100 µ zinc	steel F30 100 µ zinc	1500	1100	32
6	0.75	0.75	DC01 enamelled	DC01 enamelled	1040	730	30
6	0.75	0.75	DX51D galva- nized	DX51D galva- nized	1500	1300	30
6	0.80	0.80	AP04ZM	AP04ZM	1600	1150	33
6	0.80	0.80	DC01 galvanized + enamelled	DC01 galvanized + enamelled	1200	1000	30
6	0.80	1.00	DC03 white/gold	DX51D (Z)	1200	1150	33
6	0.90	0.90	DC01 enamelled on one side	DC01 enamelled on one side	1300	1000	32
6 S	1.00	0.60	DX56D	DX56D	1400	700	20
6	1.00	0.80	DC03 enamelled	DC03 enamelled on one side	1600	1100	33
6	1.00	1.00	DC04 hot alumi- nized	DC04 hot alumi- nized	2400	1800	35
6	1.20	1.20	steel PVC-enamelled	steel PVC-enamelled	1300	1100	33
6 S	1.50	0.60	DX56D	DX56D	2200	700	20
5	0.44	0.44	steel aluminized	steel aluminized	930	390	15
5	0.50	0.50	steel aluminized	steel aluminized	1000	550	20
5	0.55	0.55	DC01 enamelled	DC01 enamelled	1000	730	22
5	0.60	0.40	S235JR hot aluminized	S235JR hot aluminized	1100	400	20
5	0.60	1.00	DC04 aluminized	DC04 hot galva- nized	750	600	30
5	0.75	1.00	DX51D zinc-coat- ed	DX51D zinc-coat- ed	1000	700	22
5 T	1.25	0.87	DX51D	DX51D	2600	1350	34
5	1.50	0.90	DX53D galva- nized	DX51D enamelled	2400	1250	25
4	0.30	0.30	DC04 galvanized	DC04 galvanized	380	120	13
4	0.50	0.80	steel enamelled	steel enamelled	940	700	28
4	0.60	0.60	DC04 aluminized	DC04 aluminized	710	470	17
4 T	0.75	1.00	DX54D	DX51D	800	320	27
4	0.80	0.80	steel enamelled with plastic foil	steel enamelled with plastic foil	1000	800	20
3	0.60	0.60	steel galvanized	steel galvanized	400	270	8
3	0.70	0.70	steel enamelled	steel enamelled	610	360	15
3	0.85	0.85	DC01 electro-gal- vanized	DC01 hot galva- nized	1130	790	20
2	0.20	0.20	DC03+LC-MA	DC03+LC-MA	150	55	5

T = TWINpoint. Diameter per single joint.
S = SKB joint

Aluminum

TOX®-Round Joint Ø (mm)	Total sheet thickness (mm)		material/coating		shear strength (N)	tensile strength (N)	pressing force (kN)
	punch side	die side	punch side	die side			
12	3.00	3.00	ENAW-5754	ENAW-5754	3000	2850	61
12	5.20	2.80	ENAW-5019	ENAW-5019	3700	3500	66
12	5.80	5.70	aluminum profile	aluminum profile	2700	1100	64
12	6.00	3.90	aluminum profile	aluminum profile	3100	2300	64
10	1.00	1.00	ENAW-5754	ENAW-5754	1600	1100	58
10	1.00	1.20	ENAW-5754	ENAW-5754	2100	1500	45
10	1.00	1.50	ENAW-5754	ENAW-5754	1700	1800	45
10	1.20	1.50	ENAW-5754	ENAW-5083	1600	1150	36
10 S	1.50	2.50	ENAW-5182	ENAW-5182	2900	2000	45
10	2.00	1.00	ENAW-5754	ENAW-5754	3200	800	52
10	2.00	2.50	ENAW-5556A	ENAW-6082	1800	1550	44
10 S	2.50	1.50	ENAW-5182	ENAW-5182	3500	1050	41
10	2.50	2.50	ENAW-5556A	ENAW-6082	2100	1950	44
8	0.80	0.80	ENAW-5556A	ENAW-5556A	1100	800	28
8	1.00	1.00	ENAW-5754	ENAW-5754	1000	900	30
8	1.00	1.50	ENAW-5754	ENAW-5754	1100	1200	32
8	1.00	2.00	ENAW-5754	ENAW-5754	1000	1200	37
8	1.00	2.00	ENAW-5005	ENAW-5005	560	580	18
8	1.20	1.20	ENAW-6082	ENAW-5556A	1700	1400	27
8	1.50	1.00	ENAW-5754	ENAW-5754	2000	1200	40
8	2.00	1.00	ENAW-5754	ENAW-5754	2500	1300	40
8 S	2.00	1.00	AlMg4.5Mn0.4	AlMg4.5Mn0.4	3000	1000	44
8 T	3.00	2.00	AlSi1MgMn	AlMg0.7Si	2700	1200	46
6 S	0.50	0.50	Al99.5	Al99.5	250	100	12
6	1.00	1.00	ENAW-5754	ENAW-5754	1000	900	30
6	1.00	1.50	ENAW-5754	ENAW-5754	800	1000	23
6	1.50	1.00	ENAW-5754	ENAW-5754	1100	1100	20
6	2.00	1.00	ENAW-5754	ENAW-5754	1600	1200	37
5	1.00	0.80	ENAW-5182 bonazinc	ENAW-5182 bonazinc	950	600	20
3	0.50	0.50	ENAW-5556A	ENAW-5556A	210	180	7
2	0.40	0.40	Al 98.8	Al 98.8	55	50	2.2

Combined joining

TOX®-Round Joint Ø (mm)	Total sheet thickness (mm)		material/coating		shear strength (N)	tensile strength (N)	pressing force (kN)
	punch side	die side	punch side	die side			
12	4.00	1.25	S420MC	DC04	10000	5400	125
12	5.00	1.25	S355J2G4	DC04	10000	6000	115
10	1.50	1.30	steel zinc-coated	ENAW-6082 anodized	2200	1400	50
10	1.80	1.60	aluminum profile enameled	steel enameled	2200	1900	54
10	3.00	2.50	S500MC	DX52D	7500	4450	78
10	3.10	1.20	aluminum profile anodized	steel enameled	3300	3200	52
8	0.80	1.00	DC04	ENAW-5182 bonazinc	1900	1400	50
8	0.80	1.20	DC04 (ZE75)	ENAW-5182 bonazinc	2000	1500	40
8	1.00	0.80	H340LAD	DC04	3100	1000	50
8	1.20	0.80	ENAW-5182	DC04 (ZE75)	1750	1000	40
8	1.25	1.00	H340LAD	DC04	3600	2300	46
8	1.30	1.00	ENAW-6082	DC04 enameled	1300	1200	40
8 S	1.50	1.50	AlMg3.5Mn	DP-K34/60	1150	450	64
8	2.50	1.20	ENAW-5754	1.4016	2550	1400	47
6	0.50	1.00	1.4301 with plastic foil	DC01 zinc-coated	1050	600	30
6	0.60	1.20	DC01	H340LAD	950	720	35
6	0.80	1.25	1.4301	ENAW-6082	1400	500	40
6	1.00	1.00	aluminum	DC01 zinc-coated	720	450	28
6	1.00	1.00	aluminum anodized	DC01 electro galvanized	1100	700	31
6	1.00	2.00	ENAW-5556A	zinc die-casting	560	300	22
6	1.40	1.20	ENAW-6082	DC04 enameled	1080	800	30
5	1.00	0.40	DC01 zinc-coated	1.4301	1550	400	26
5	1.00	1.50	DC01 (ZE75)	zinc die-casting	1030	200	23
3	0.80	0.60	DC01 zinc-coated	CW452K	520	310	11

Aluminum surface treated

TOX®-Round Joint Ø (mm)	Total sheet thickness (mm)		material/coating		shear strength (N)	tensile strength (N)	pressing force (kN)
	punch side	die side	punch side	die side			
8	1.20	1.20	aluminum anodized	Al 99.5	1600	1100	82
8	1.40	1.20	ENAW-5754 anodized	ENAW-5556A KTL-enameled	1750	1650	36
8	1.70	1.30	ENAW-6082 anodized	ENAW-6082 anodized	2100	1900	37
8	4.00	2.00	aluminum profile	aluminum sheet enameled	3400	2400	51
6	0.50	0.50	aluminum enameled	aluminum enameled	530	400	12

T = TWINpoint. Diameter per single joint.
S = SKB joint

... and many more combinations. Please order your test report!

Order form for TOX®-Test Report

TOX® PRESSOTECHNIK offers the only way for a reliable application of clinching with functional guarantee!

Please fill in the framed areas as completely as possible.

<p>Your name and address:</p> <p>Tel.-No.</p> <p>Fax-No.</p> <p>E-Mail</p> <p>Your TOX® PRESSOTECHNIK contact person:</p>	<p>Choose from following TOX®-Test alternatives:</p> <p>1. Qualification test, TOX®-Test Report with joint strength data of test sample strips, joining of up to 2 components. With the supply of 20 sheet metal strips minimum 25x50 mm or adequate flat metal sheets, for material on punch and die side each. Free of charge <input type="checkbox"/></p> <p>Additional to 1:</p> <p>2. With components supplied, requiring preparatory work for test samples, at cost. <input type="checkbox"/></p> <p>Additional to 1 or 2:</p> <p>3. Joining of component samples. Quantity pcs. <input type="checkbox"/></p>
--	---

Information on your application:

Project / component designation: Production rate per year: Required/calculated joint strength: Shear Strength (N), Pull Strength(N), Data not available <input type="checkbox"/> Anticipated start of production:

For the TOX®-Tests the following information is also required together with the, the above mentioned test material:

Requested TOX®-Joint Ø (mm), please circle: 1.5, 2, 3, 4, 5, 6, 8, 10, 12, 14, 16, 18, 26, best possible	Round joint or variant (see catalog TOX®-Joining Systems):	
Material (punch side): Thickness (mm): Coating (type, thickness): Surface: dry <input type="checkbox"/> oily <input type="checkbox"/>		Material (die side): Thickness (mm): Coating (type, thickness): Surface: dry <input type="checkbox"/> oily <input type="checkbox"/>
Intermediate layer <input type="checkbox"/> no <input type="checkbox"/> yes, material:	Thickness:	Coating:

Supplementary information/sketch/drawing